

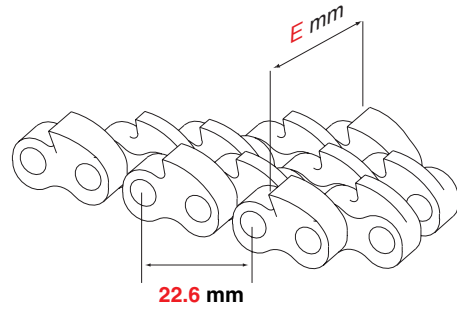

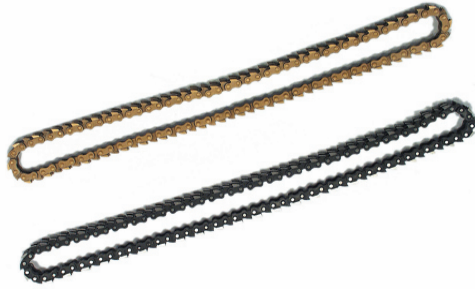





# MORTAISAGE : CHAINES PAS A (22,6)



MORTISING : Chain pitch A (22,6)  
 AUSKERBUNG : Ketten mit Teilung A (22,6)  
 ESCOPLEADURA : Cadena paso A (22,6)  
 MORTASAGGIO : Catene passo A (22,6)



e	E	C									
			CODE	CODE	CODE	CODE	CODE	CODE	CODE	CODE	CODE
2.50	6	C	MORT6A29	MORT6A30	MORT6A32	MORT6A34	MORT6A36	MORT6A38	MORT6A	MORT0219	
		C	MORT6AC29	MORT6AC30	MORT6AC32	MORT6AC34	MORT6AC36	MORT6AC38	MORT6AC	MORT0219	
	7	C	MORT7A29	MORT7A30	MORT7A32	MORT7A34	MORT7A36	MORT7A38	MORT7A	MORT0220	
		C	MORT7AC29	MORT7AC30	MORT7AC32	MORT7AC34	MORT7AC36	MORT7AC38	MORT7AC	MORT0220	
	4.00	8	C	MORT8A29	MORT8A30	MORT8A32	MORT8A34	MORT8A36	MORT8A38	MORT8A	MORT0221
			C	MORT8AC29	MORT8AC30	MORT8AC32	MORT8AC34	MORT8AC36	MORT8AC38	MORT8AC	MORT0221
9		C	MORT9A29	MORT9A30	MORT9A32	MORT9A34	MORT9A36	MORT9A38	MORT9A	MORT0222	
		C	MORT9AC29	MORT9AC30	MORT9AC32	MORT9AC34	MORT9AC36	MORT9AC38	MORT9AC	MORT0222	
10		C	MORT10A29	MORT10A30	MORT10A32	MORT10A34	MORT10A36	MORT10A38	MORT10A	MORT0223	
		C	MORT10AC29	MORT10AC30	MORT10AC32	MORT10AC34	MORT10AC36	MORT10AC38	MORT10AC	MORT0223	
9.00	11	C	MORT11A29	MORT11A30	MORT11A32	MORT11A34	MORT11A36	MORT11A38	MORT11A	MORT0224	
		C	MORT11AC29	MORT11AC30	MORT11AC32	MORT11AC34	MORT11AC36	MORT11AC38	MORT11AC	MORT0224	
	12	C	MORT12A29	MORT12A30	MORT12A32	MORT12A34	MORT12A36	MORT12A38	MORT12A	MORT0225	
		C	MORT12AC29	MORT12AC30	MORT12AC32	MORT12AC34	MORT12AC36	MORT12AC38	MORT12AC	MORT0225	
	13	C	MORT13A29	MORT13A30	MORT13A32	MORT13A34	MORT13A36	MORT13A38	MORT13A	MORT0226	
		C	MORT13AC29	MORT13AC30	MORT13AC32	MORT13AC34	MORT13AC36	MORT13AC38	MORT13AC	MORT0226	
13.50	14	C	MORT14A29	MORT14A30	MORT14A32	MORT14A34	MORT14A36	MORT14A38	MORT14A	MORT0227	
		C	MORT14AC29	MORT14AC30	MORT14AC32	MORT14AC34	MORT14AC36	MORT14AC38	MORT14AC	MORT0227	
	15	C	MORT15A29	MORT15A30	MORT15A32	MORT15A34	MORT15A36	MORT15A38	MORT15A	MORT0228	
		C	MORT15AC29	MORT15AC30	MORT15AC32	MORT15AC34	MORT15AC36	MORT15AC38	MORT15AC	MORT0228	
	16	C	MORT16A29	MORT16A30	MORT16A32	MORT16A34	MORT16A36	MORT16A38	MORT16A	MORT0229	
		C	MORT16AC29	MORT16AC30	MORT16AC32	MORT16AC34	MORT16AC36	MORT16AC38	MORT16AC	MORT0229	
22.50	18	C	MORT18A29	MORT18A30	MORT18A32	MORT18A34	MORT18A36	MORT18A38	MORT18A	MORT0230	
		C	MORT18AC29	MORT18AC30	MORT18AC32	MORT18AC34	MORT18AC36	MORT18AC38	MORT18AC	MORT0230	
	20	C	MORT20A29	MORT20A30	MORT20A32	MORT20A34	MORT20A36	MORT20A38	MORT20A	MORT0231	
		C	MORT20AC29	MORT20AC30	MORT20AC32	MORT20AC34	MORT20AC36	MORT20AC38	MORT20AC	MORT0231	
	22	C	MORT22A29	MORT22A30	MORT22A32	MORT22A34	MORT22A36	MORT22A38	MORT22A	MORT0232	
		C	MORT22AC29	MORT22AC30	MORT22AC32	MORT22AC34	MORT22AC36	MORT22AC38	MORT22AC	MORT0233	
25	C	MORT25A29	MORT25A30	MORT25A32	MORT25A34	MORT25A36	MORT25A38	MORT25A	MORT0234		
	C	MORT25AC29	MORT25AC30	MORT25AC32	MORT25AC34	MORT25AC36	MORT25AC38	MORT25AC	MORT0234		
28	C	MORT28A29	MORT28A30	MORT28A32	MORT28A34	MORT28A36	MORT28A38	MORT28A	MORT0235		
	C	MORT28AC29	MORT28AC30	MORT28AC32	MORT28AC34	MORT28AC36	MORT28AC38	MORT28AC	MORT0235		
30	C	MORT30A29	MORT30A30	MORT30A32	MORT30A34	MORT30A36	MORT30A38	MORT30A	MORT0236		
	C	MORT30AC29	MORT30AC30	MORT30AC32	MORT30AC34	MORT30AC36	MORT30AC38	MORT30AC	MORT0236		