

561720

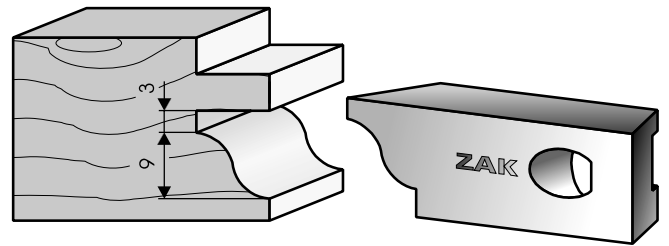

561721

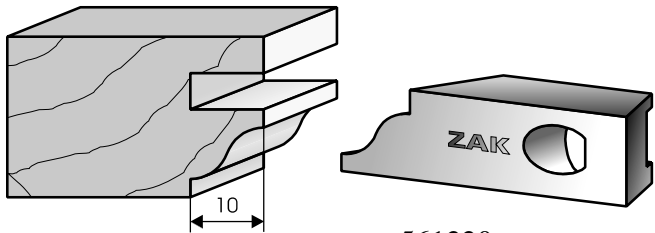

561220

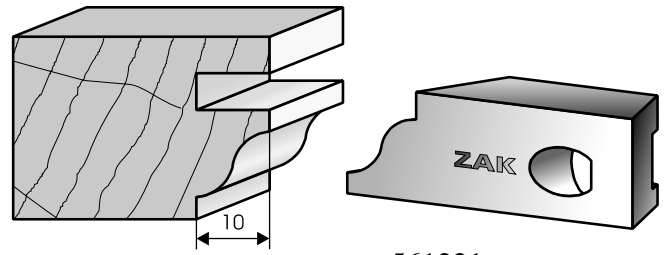

561221

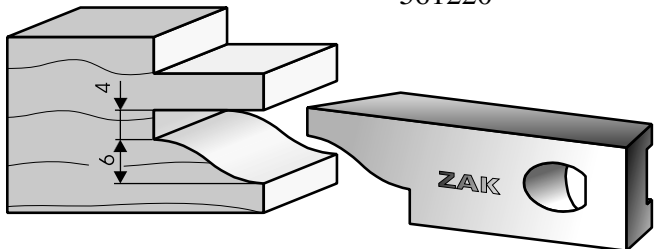

561722

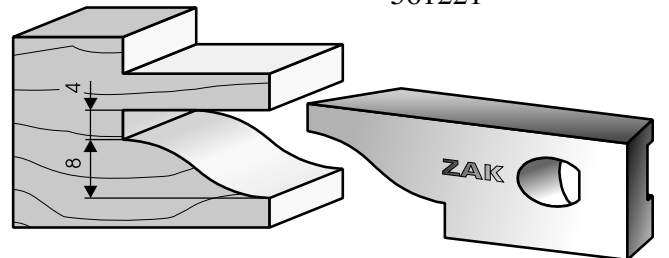

561723

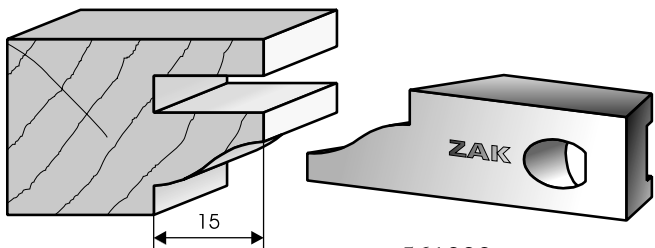

561222

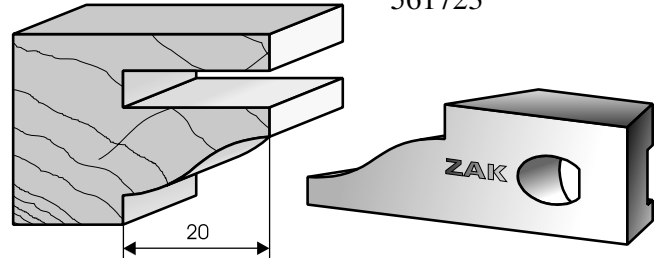

561223

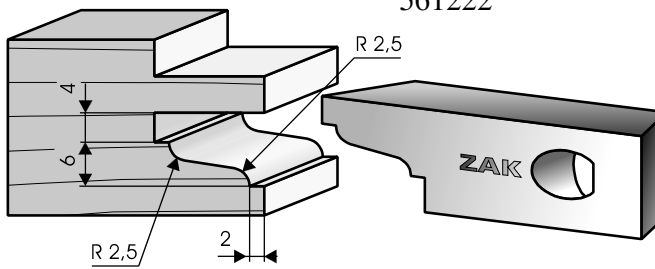

561725

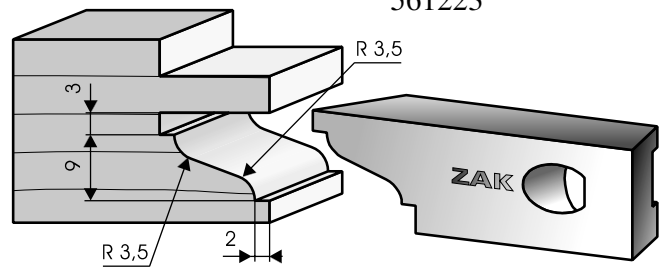

561726

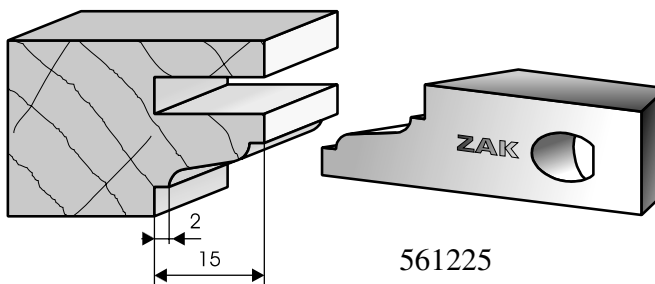

561225

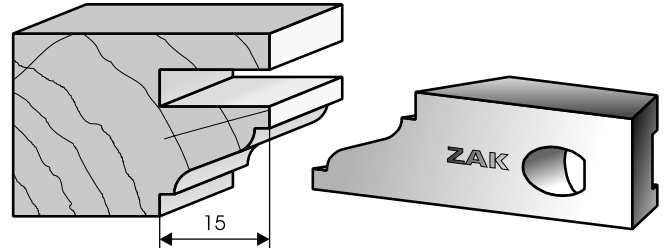

561226

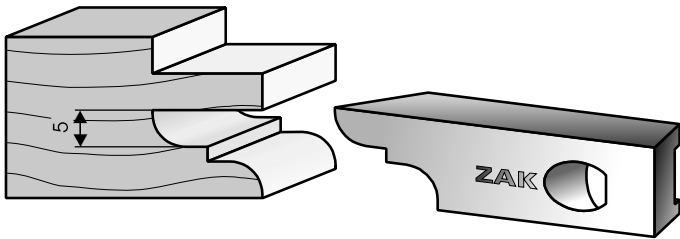

561741

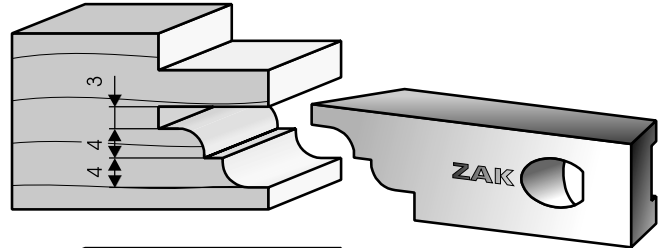

561745

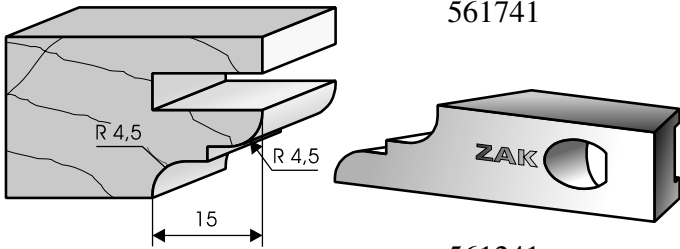

561241

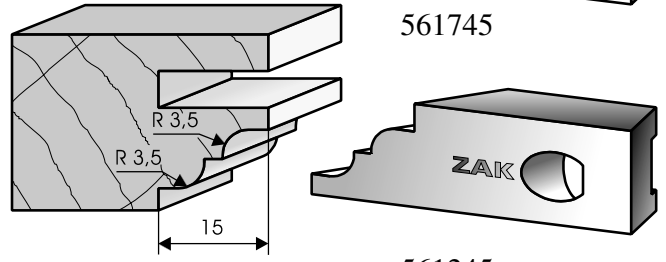

561245

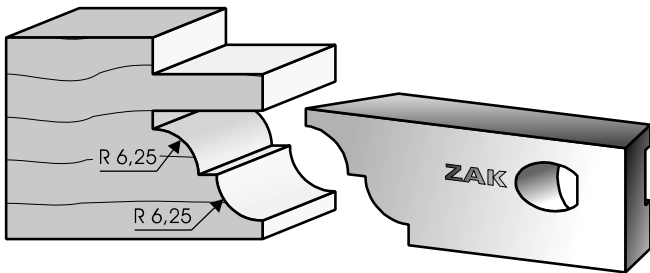

561746

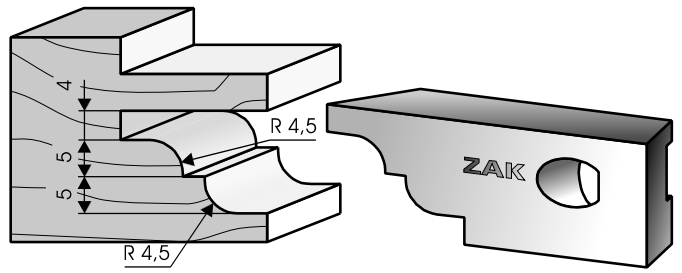

561747

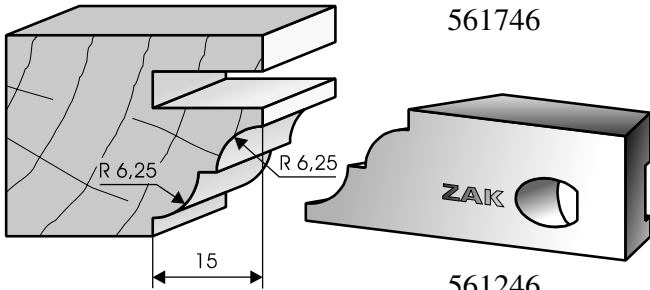

561246

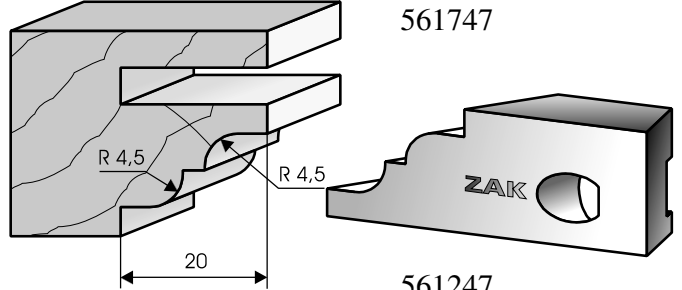

561247

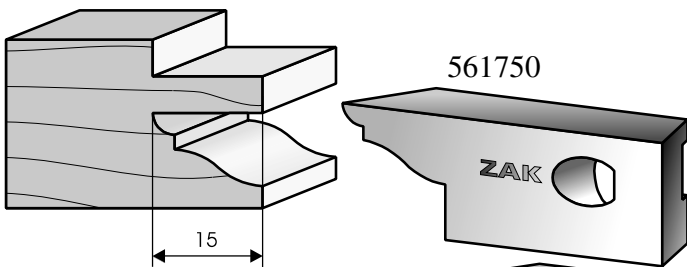

561750

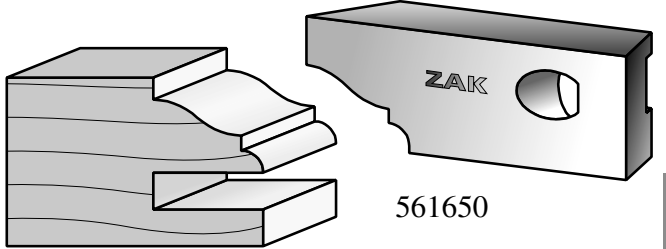

561650

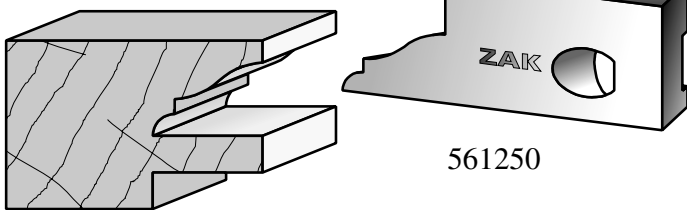

561250

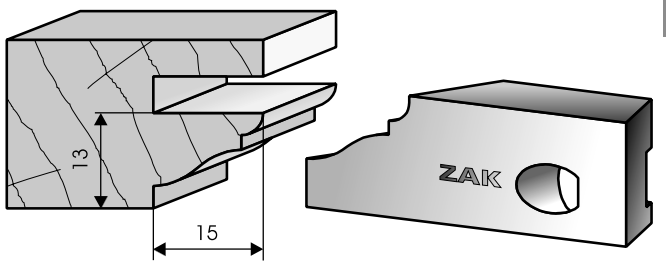

561350

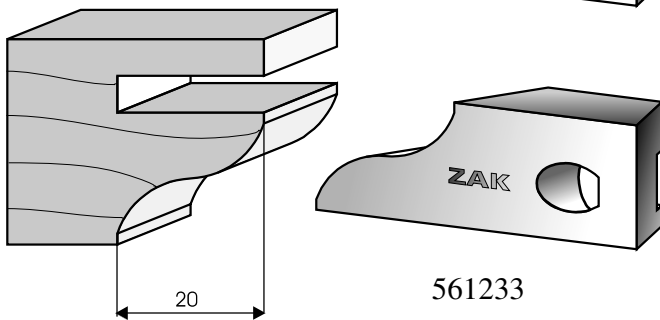
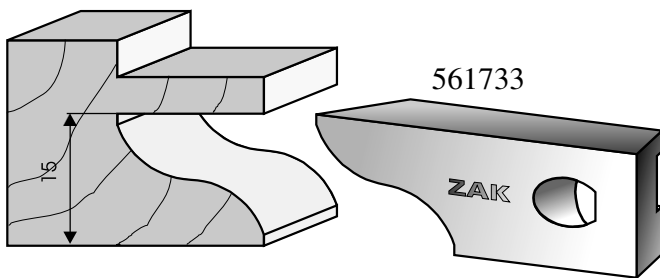
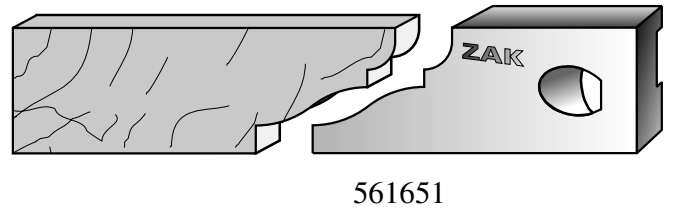
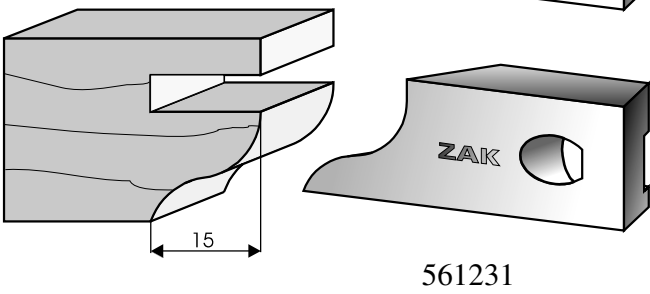
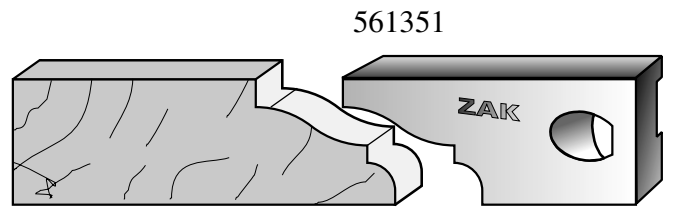
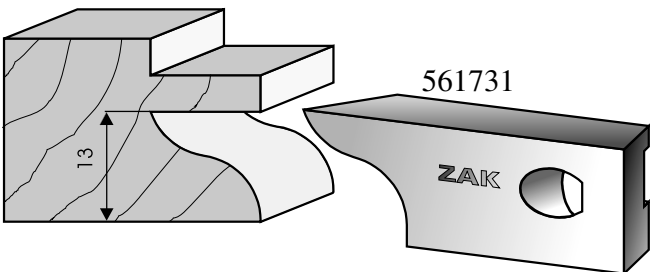
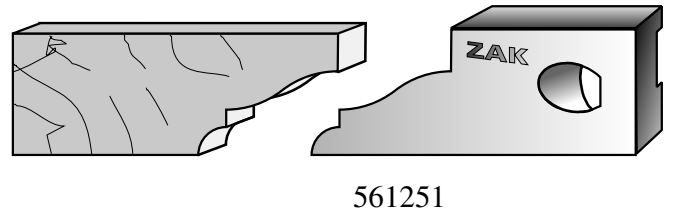
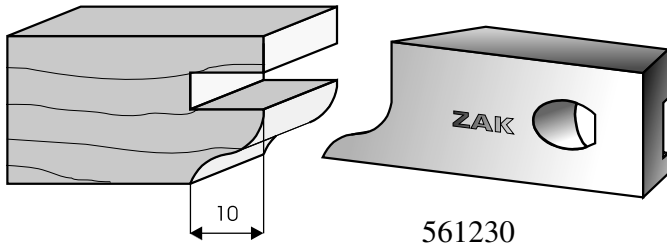
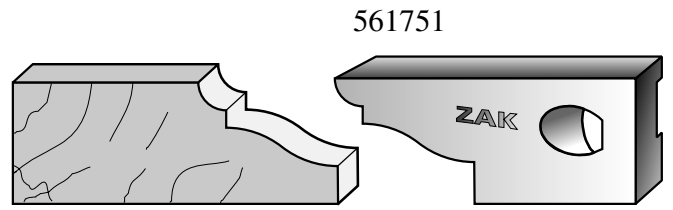
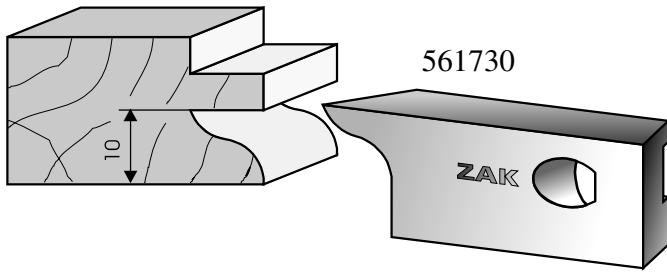

AVEC CE PROFIL, 2 MOULURES POSSIBLES...

AVANCEMENT DE 15

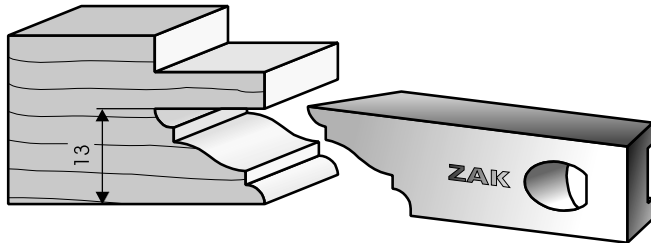

561756

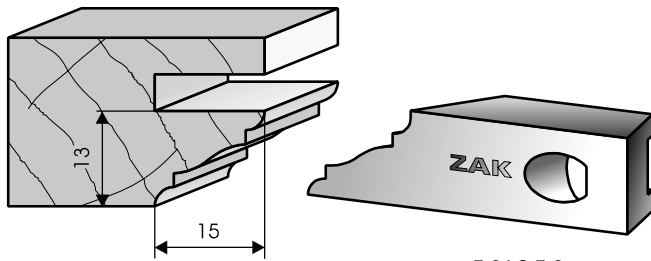

561256

AVANCEMENT DE 12,5

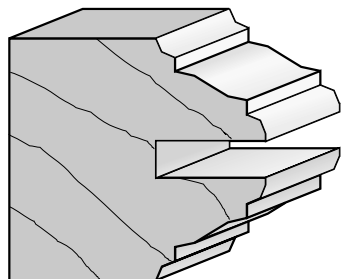
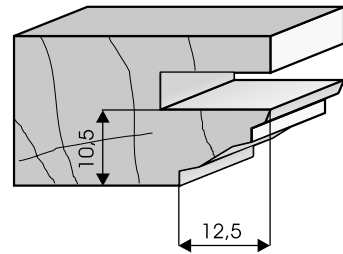
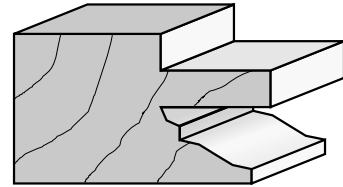

*Profil double parement*

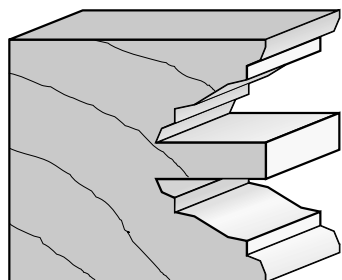
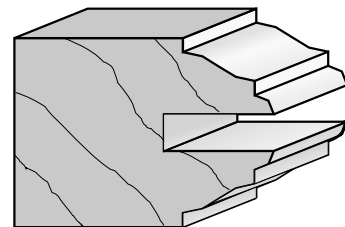

*Contre-profil double parement*

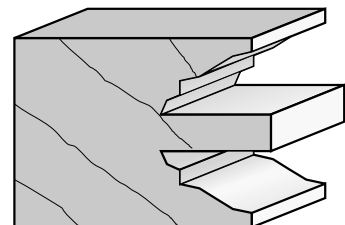

AVEC CE PROFIL, 2 MOULURES POSSIBLES...

AVANCEMENT DE 20

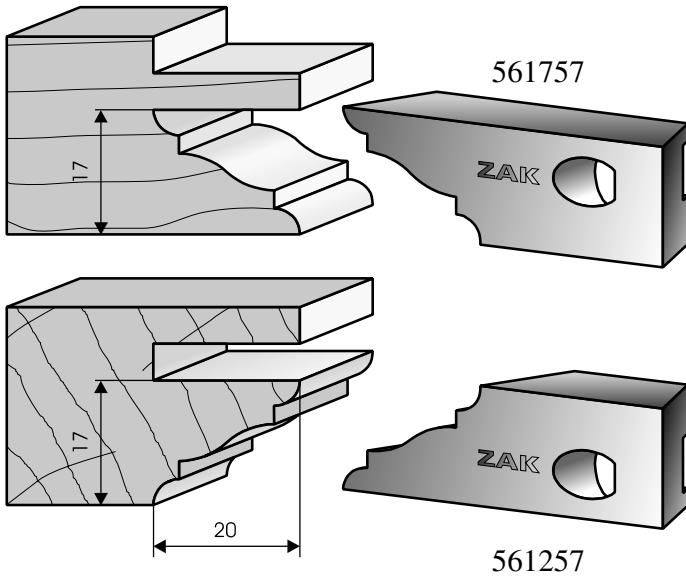

AVANCEMENT DE 16,5

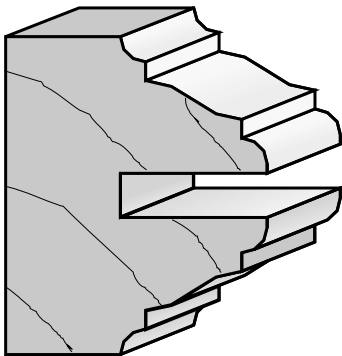
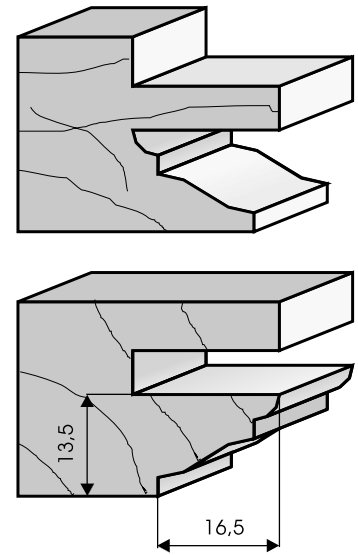

*Profil double parement*

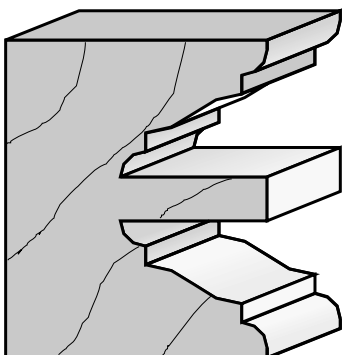
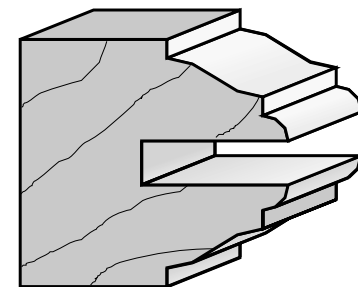

*Contre-profil double parement*

