

MORTAISAGE : GUIDES, PIGNONS, EMBOUTS, VIS





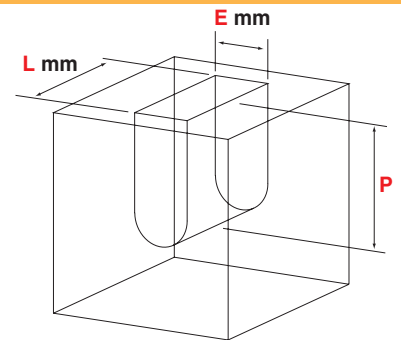
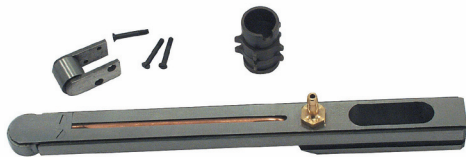

SPROCKETS GUIDES, FERRULES, SCREWS
 FÜHRUNGEN, ANTRIEBSRÄDER, ANSÄTZE, SCHRAUBEN
 ESPADA PIÑONES, CONTRERAS, TORTILLOS
 GUIDE, PIGNONI, ATTACHI

MORTAISAGE : GUIDES PIGNONS, EMBOUTS, VIS POUR CHAÎNE DE PAS B (15,8)

Mortising for chain of pitch B (15,8)
 Auskerbung für Ketten mit Teilung B (15,8)
 Escopleadura para cadena de paso B (15,8)
 Mortasaggio per catena di passo B (15,8)





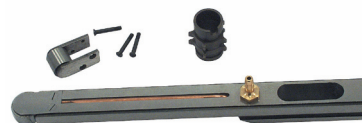

| Chemin de roulement Rolling path Abroll-Länge Camino de rodamiento Cammino di cuscinetto e | Dim. Mortaise Mortise dimensions Bohr-Abmessung Dimensiones muesca Dim. mortasa | | |  |  |  |  |  |
|---|---|----|-----|---|---|---|---|---|
| | E | L | P | | | | | |
| 2.50 | 6/7 | 30 | 100 | MORT0001 | MORT0010 | MORT0010 | MORT0015 | MORT0024 |
| | 8/12 | 25 | 100 | MORT0002 | MORT0011 | MORT0275 | MORT0016 | MORT0025 |
| 4.00 | 8/12 | 30 | 110 | MORT0003 | MORT0011 | MORT0275 | MORT0017 | MORT0025 |
| | 8/12 | 35 | 110 | MORT0004 | MORT0011 | MORT0275 | MORT0018 | MORT0025 |
| 9.00 | 13/20 | 25 | 100 | MORT0005 | MORT0012 | MORT0276 | MORT0019 | MORT0026 |
| | 13/20 | 25 | 125 | MORT132025125 | MORT0012 | MORT0276 | MORT0019 | MORT0026 |
| | 13/20 | 30 | 110 | MORT0006 | MORT0012 | MORT0276 | MORT0020 | MORT0026 |
| | 13/20 | 25 | 125 | MORT132030125 | MORT0012 | MORT0276 | MORT0020 | MORT0026 |
| | 13/20 | 35 | 110 | MORT0007 | MORT0012 | MORT0276 | MORT0021 | MORT0026 |
| | 13/20 | 35 | 125 | MORT132035125 | MORT0012 | MORT0276 | MORT0021 | MORT0026 |
| | 13/20 | 35 | 125 | MORT132035125 | MORT0013 | MORT0276 | MORT0022 | MORT0027 |
| 13.50 | 22/25 | 30 | 110 | MORT0008 | MORT0013 | MORT0010 | MORT0022 | MORT0027 |
| | 22/25 | 35 | 125 | MORT222530125 | MORT0013 | MORT0010 | MORT0022 | MORT0027 |
| 22.50 | 30 | 30 | 110 | MORT0009 | MORT0014 | MORT0010 | MORT0023 | MORT0028 |
| | 30 | 30 | 125 | MORT3030125 | MORT0014 | MORT0010 | MORT0023 | MORT0028 |

MORTAISAGE : GUIDES, PIGNONS, EMBOUTS, VIS POUR CHAÎNE DE PAS A (22,6)

Mortising for chain of pitch A (22,6)
 Auskerbung für Ketten mit Teilung A (22,6)
 Escopleadura para cadena de paso A (22,6)
 Mortasaggio per catena di passo A (22,6)

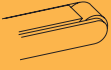

| Chemin de roulement Rolling path Abroll-Länge Camino de rodamiento Cammino di cuscinetto e | Dim. Mortaise Mortise dimensions Bohr-Abmessung Dimensiones muesca Dim. mortasa | | |  |  |  |  |  |
|---|---|----|-----|---|---|---|---|---|
| | E | L | P | | | | | |
| 2.50 | 6/7 | 40 | 150 | MORT640150 | MORT237 | | MORT204 | MORT214 |
| | 6/7 | 50 | 150 | MORT650150 | | MORT238 | MORT205 | MORT214 |
| 4.00 | 8/12 | 40 | 150 | MORT840150 | MORT239 | | MORT206 | MORT215 |
| | 8/12 | 50 | 150 | MORT850150 | | MORT240 | MORT207 | MORT215 |
| 9.00 | 13/20 | 40 | 150 | MORT1340150 | MORT241 | | MORT208 | MORT216 |
| | 13/20 | 50 | 150 | MORT1350150 | | MORT242 | MORT209 | MORT216 |
| 13.50 | 22/25 | 40 | 150 | MORT2240150 | MORT243 | | MORT210 | MORT217 |
| | 22/25 | 50 | 150 | MORT2250150 | | MORT244 | MORT211 | MORT217 |
| 22.50 | 30 | 40 | 150 | MORT3040150 | MORT245 | | MORT212 | MORT218 |
| | 30 | 50 | 150 | MORT3050150 | | MORT246 | MORT213 | MORT218 |